

























# N30 Nat

## Datenblatt



Abbildung: N30 (Nat) | Naturstein: Blanco Nacarado

Standard	Gesamtgewicht	Optional	Zubehör	Naturstein	Kamineinsatz
 Front Kristall	 ca. 335 kg	 Doppelverglasung	 Heizwasser-Aufsatzregister R	 Blanco Carrara	 Lina 6757 h NW-Leistung: 9 kW Abgasstutzen: Ø 180 mm  Energieeffizienzklasse nach (EU) 2015/1186 für Kamineinsatz Mehr Infos unter <a href="http://www.camina-schmid.de">www.camina-schmid.de</a>
 Tür hochschiebbar		 Tunnelversion	 Aufsatzspeicher	 Blanco Macael	
		 Warmluft-Aufsatzregister	 Elektronischer Türantrieb	 Blanco Nacarado	
		 Außenbefeuerung	 SMR	 Caliza Moka	
		 Vorlegeplatte		 Crema Marfil	
				 Marron Emperador	
				 Travertino Romano	
				 Negro Abanilla	
				 Rojo Alicante	
				 Rosa Claro	
				 Rosa Crema	
				Weitere Natursteinausführungen auf Anfrage erhältlich.	

# N30 Nat

## Maßzeichnung

Frontansicht M 1:25

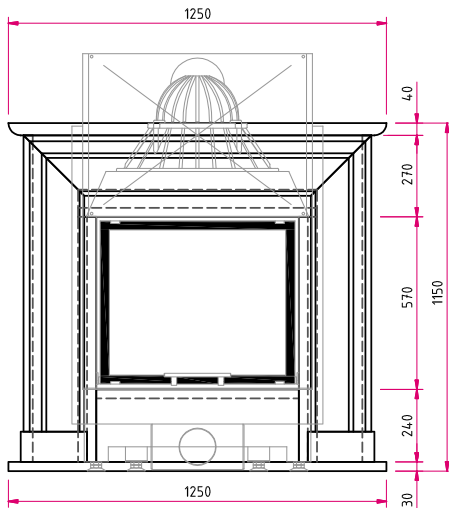

Seitenansicht M 1:25

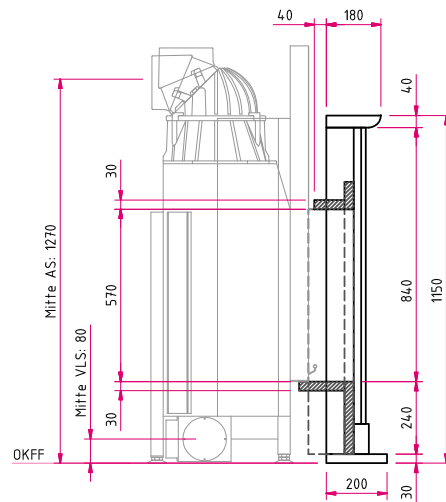

Draufsicht M 1:25

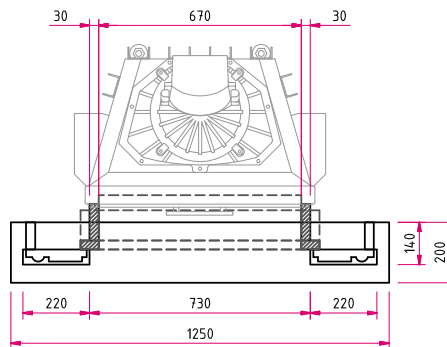

**Hinweis Seitenansicht M 1:25:** AS: Abgasstutzen, VLS: Verbrennungsluftstutzen, OKFF: Oberkante Fertigfußboden

Bitte beachten Sie die Angaben für **optionales Zubehör** in unserer Preisliste.

Abbildungen ähnlich. Alle Abbildungen und Zeichnungen sind urheberrechtlich geschützt. Verwertung oder Veröffentlichung, auch einzelner Details, nur mit unserer Genehmigung. Farbliche und technische Änderungen durch Weiterentwicklungen sowie Irrtümer vorbehalten. Stand: 07/2018