

























N3

Datenblatt



Abbildung: N3 | Naturstein (zweifarbzig): Blanco Nacarado mit Habana

Standard	Gesamtgewicht	Optional	Zubehör	Naturstein	Kamineinsatz	
 Front Kristall	 ca. 620 kg	 Doppelverglasung	 Heizwasser-Aufsatzregister R	 Aufsatzspeicher	 Lina 7357 h NW-Leistung: 9 kW Abgasstutzen: Ø 200 mm  Energieeffizienzklasse nach (EU) 2015/1186 für Kamineinsatz Mehr Infos unter www.camina-schmid.de	
 Tür hochschiebbar		 Tunnelversion	 Wärmeluft-Aufsatzregister	 Elektronischer Türantrieb		
			 Außenbefeuerung	 SMR		
			 Vorlegeplatte			
				 Blanco Carrara		 Blanco Macael
				 Blanco Nacarado		 Caliza Moka
				 Crema Marfil		 Marron Emperador
				 Travertino Romano		 Negro Abanilla
				 Rojo Alicante		 Rosa Claro
				 Rosa Crema		

Weitere Natursteinausführungen auf Anfrage erhältlich.

N3

Maßzeichnung

Frontansicht M 1:25

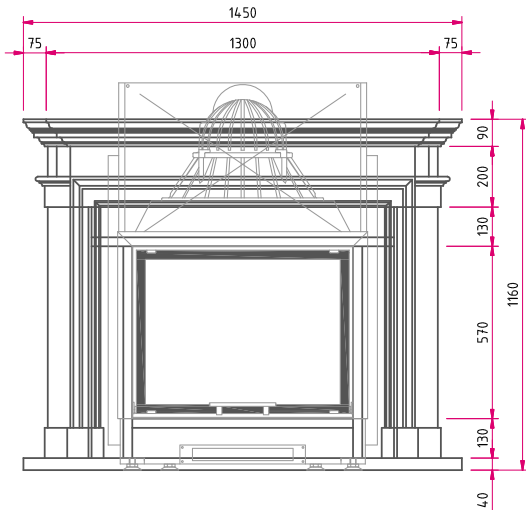

Seitenansicht M 1:25

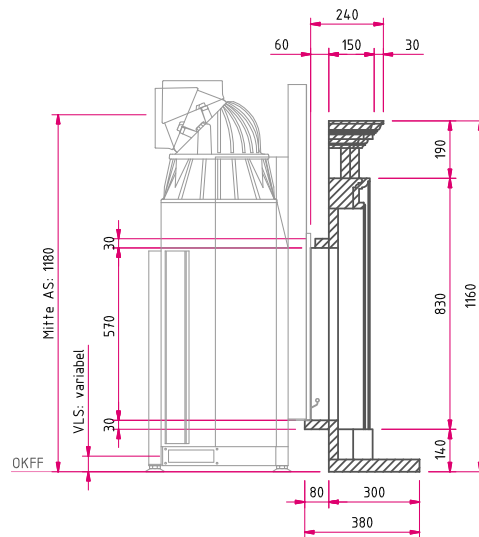

Draufsicht M 1:25

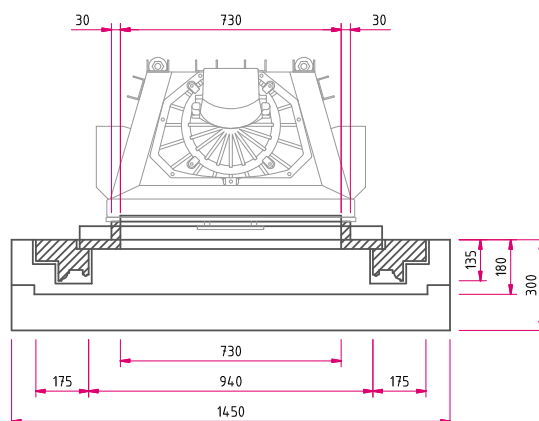

Hinweis Seitenansicht M 1:25: AS: Abgasstutzen, VLS: Verbrennungsluftstutzen, OKFF: Oberkante Fertigfußboden

Bitte beachten Sie die Angaben für **optionales Zubehör** in unserer Preisliste.

Abbildungen ähnlich. Alle Abbildungen und Zeichnungen sind urheberrechtlich geschützt. Verwertung oder Veröffentlichung, auch einzelner Details, nur mit unserer Genehmigung. Farbliche und technische Änderungen durch Weiterentwicklungen sowie Irrtümer vorbehalten. Stand: 07/2018