

























# N16

## Datenblatt



Abbildung: N16 | Naturstein: Crema Marfil

Standard	Gesamtgewicht	Optional	Zubehör	Naturstein	Kamineinsatz
 Front Kristall	 ca. 500 kg	 Front Kristall + (außer Lina W)	 Heizwasser-Aufsatzregister R  Kesselgerät Lina W  Aufsatzspeicher  Warmluft-Aufsatzregister  Elektronischer Türantrieb  SMR  Außenbefuerung  Vorlegeplatte	 <i>Blanco Carrara</i>  <i>Blanco Macael</i>  <i>Blanco Nacarado</i>  <i>Caliza Moka</i>  <i>Crema Marfil</i>  <i>Marron Emperador</i>  <i>Travertino Romano</i>  <i>Negro Abanilla</i>  <i>Rojo Alicante</i>  <i>Rosa Claro</i>  <i>Rosa Crema</i>	 Lina 7363 h NW-Leistung: 9 kW Abgasstutzen: Ø 200 mm  Energieeffizienzklasse nach (EU) 2015/1186 für Kamineinsatz Mehr Infos unter <a href="http://www.camina-schmid.de">www.camina-schmid.de</a>
				Weitere Natursteinausführungen auf Anfrage erhältlich.	

# N16

## Maßzeichnung

Frontansicht M 1:25

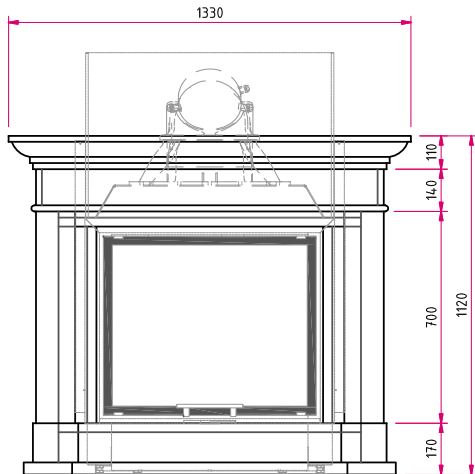

Seitenansicht M 1:25

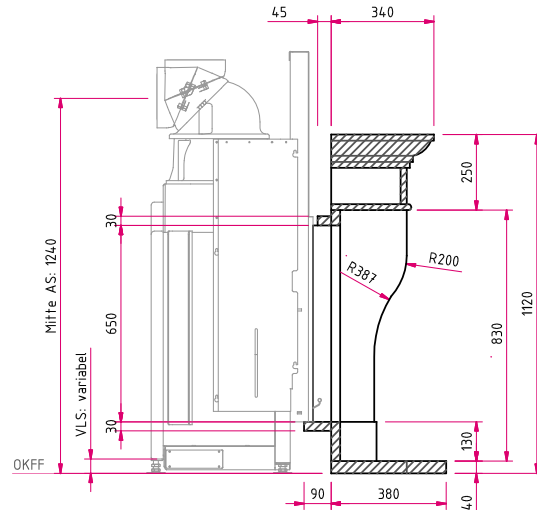

Draufsicht M 1:25

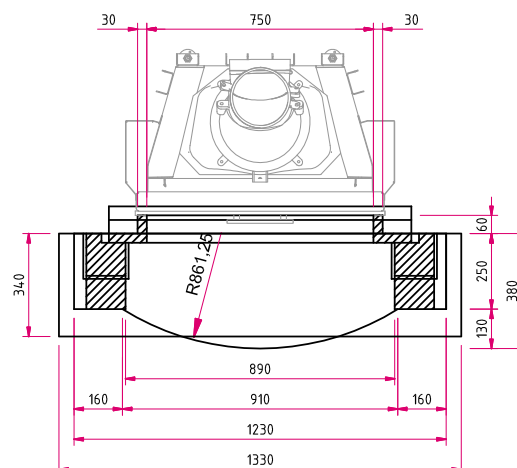

**Hinweis Seitenansicht M 1:25:** AS: Abgasstutzen, VLS: Verbrennungsluftstutzen, OKFF: Oberkante Fertigfußboden

Bitte beachten Sie die Angaben für **optionales Zubehör** in unserer Preisliste.

Abbildungen ähnlich. Alle Abbildungen und Zeichnungen sind urheberrechtlich geschützt. Verwertung oder Veröffentlichung, auch einzelner Details, nur mit unserer Genehmigung. Farbliche und technische Änderungen durch Weiterentwicklungen sowie Irrtümer vorbehalten. Stand: 07/2018