

























N3

Data sheets



Figure: N3 | Natural stone (two-tone): Blanco Nacarado with Habana

Standard	Total weight	Optional	Accessories	Natural stone	Fireplace insert
 Front Kristall	 approx. 620 kg	 Double glass	 Hot water top-mounted element  Top mounted heat exchanger	 <i>Blanco Carrara</i>  <i>Blanco Macael</i>	
 Guillotine door		 Tunnel version	 Hot air top-mounted element  Electric door drive	 <i>Blanco Nacarado</i>  <i>Caliza Moka</i>	Lina 7357 h Nominal heat output: 9 kW Flue gas connector: Ø 200 mm
			 External fuel-door  SMR	 <i>Crema Marfil</i>  <i>Marron Emperador</i>	
			 Spark protection plate	 <i>Travertino Romano</i>  <i>Negro Abanilla</i>	Energy efficiency class as per (EU) 2015/1186 for fireplace insert
				 <i>Rojo Alicante</i>  <i>Rosa Claro</i>	More information at www.camina-schmid.de
				 <i>Rosa Crema</i>	
				Natural stone façade also available separately!	

N3

Dimensional drawing

Front view, scale 1:25

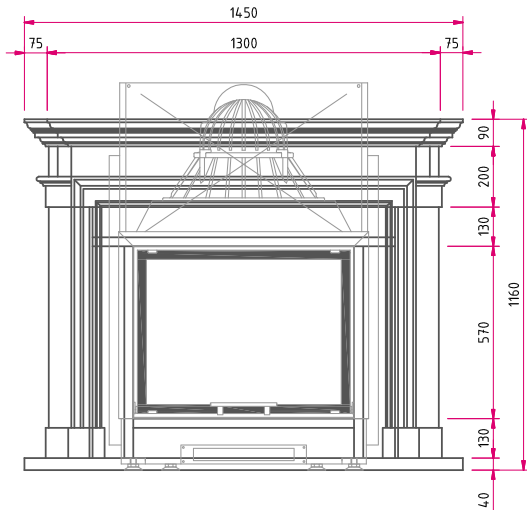

Left side view, scale 1:25

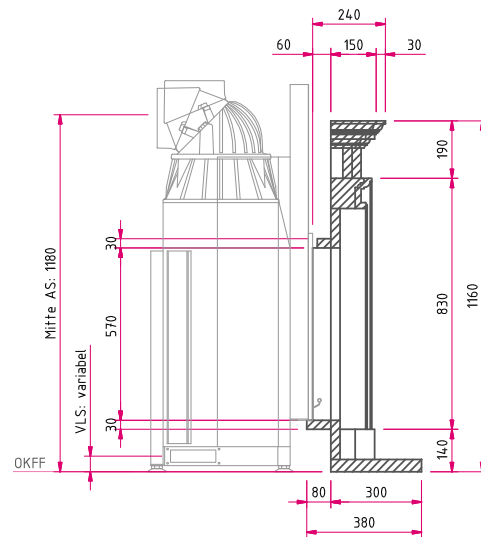

Top view, scale 1:25

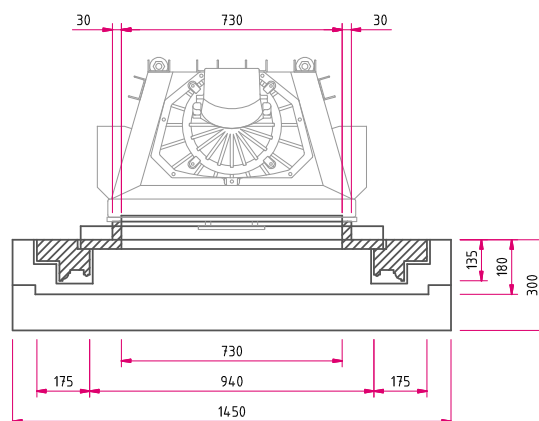

Note on left side view, scale 1:25: AS (FGC): Flue gas connector, VLS (CAC): Combustion air connector, OKFF (FFL): Finished floor level

Please note the information on **optional accessories** in our price list.

Illustrations are similar. All photos and drawings are protected by copyright. Usage or publication, even of individual details, is only permitted with our authorisation. There may be modifications to the colour and technical details caused by ongoing developments; subject to errors and omissions. Dated: 07/2018